

# Thomson Electrak® Smart Linear Actuators

Electric Solutions Featuring Onboard Electronics for Enhanced Control





## Designing Smart Machines Starts with Smart Tools

As the industrial world becomes increasingly connected, the designer's need for intelligent components that can communicate with each other and operate without the need for manual interaction is growing. Thomson, a trusted manufacturer that has always been committed to staying ahead of the technology curve, is meeting this demand and helping to usher in a new generation of smart actuators.

### What are Smart Actuators?

The crux of smart actuators begins with the integration of onboard electronics, which enables enhanced control functions that were previously external, such as switching, position feedback and system diagnostics, directly into the actuator. Newer actuators from Thomson incorporate microprocessor-based printed circuit boards with complementary software that allows communication between remote networks.

### Benefits

- Increased efficiency and productivity.
- Enhanced diagnostic capabilities and controllability.
- Fewer components and less cabling.
- Minimized complexity and easier installation.
- Reduced hardware and software costs.
- Decreased machine development time and weight.
- Improved machine functionality and performance.
- Bus communication between host control and actuators.
- Position-based synchronization without having to add any extra external controls.
- Better and more accurate controllability.
- Speed, position and force control.
- Enhanced diagnostic and monitoring capabilities.



# SMART ACTUATORS

**IMPROVE**

**EFFICIENCY  
DIAGNOSTICS  
PRODUCTIVITY  
PERFORMANCE  
CONTROLLABILITY**

**REDUCE**

**COMPLEXITY  
ENGINEERING  
COMPONENTS  
OVERALL COSTS  
INSTALLATION TIME**





# Smart Actuators Overview

## Electrak® XD

Ushering in the next evolution of electric actuators, the Electrak XD is strong enough to take on hydraulic applications while, at the same time, be smarter, smaller and more efficient than competitive technologies. On top of its strength (up to 25,000 N loads), the XD offers extensive protection against even the harshest conditions and ingress, and features enhanced controllability and diagnostics via onboard controls. [www.thomsonlinear.com/xd](http://www.thomsonlinear.com/xd)

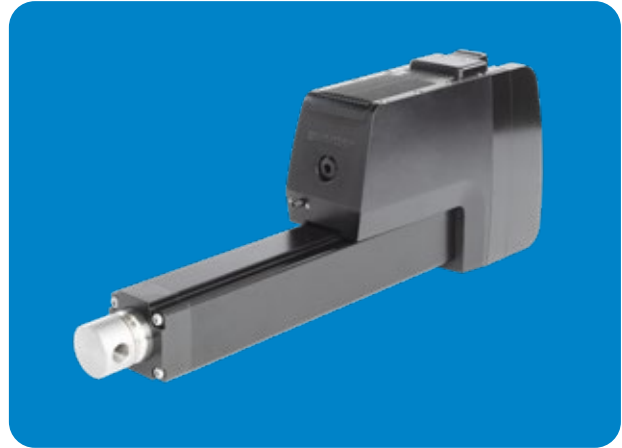

## Electrak HD

The Electrak HD sets the bar for the electric linear actuator platform. Onboard electronics can eliminate the need for standalone controls, higher power opens a wider range of hydraulic and pneumatic applications to electric conversion, and it meets the most extreme environmental acceptance tests. [www.thomsonlinear.com/hd](http://www.thomsonlinear.com/hd)

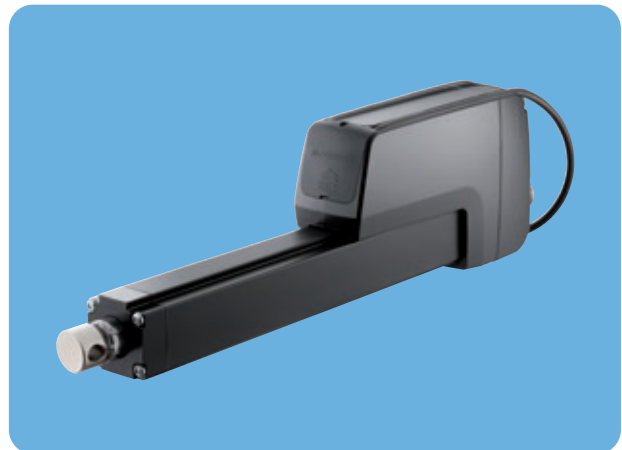

Specifications		
	Electrak XD	Electrak HD
Screw type	ball	ball
Manual override / anti-rotation / dynamic braking	yes / yes / yes	yes / yes / yes
Static load holding / internal limit switches	yes / yes	yes / yes
Available input voltages [VDC]	24, 48	12, 24, 48
Max. static load / dynamic load (Fx) [N (lbs)]	32000 (7194) / 25000 (5620)	18000 (4050) / 16000 (3600)
Speed @ no load/max. load [mm/s (in/s)]	75 (2.95) <sup>(1)</sup>	71/58 (2.80/2.28)
Max. ordering stroke (S) length [mm]	1200	1000
Operating temperature limits [°C (F)]	- 40 - 85 (- 40 - 185)	- 40 - 85 (- 40 - 185)
Full load duty cycle @ 25°C (77°F) [%]	50	25
Protection class - static	IP67 / IP69K	IP67 / IP69K
Salt spray resistance [h]	500	500

<sup>1</sup> Constant speed motor.

### Electrak LL

Designed for long life, high duty cycle and the ability to work in the harshest environments, Electrak LL actuators with brushless motors deliver bar-setting, world-class performance with 100% duty cycle and up to 600 km (375 miles) of maintenance-free life. The LL smart electric actuator is well suited for many applications – most notably mobile battery powered ones – that previously have had to employ more expensive and complex solutions.

[www.thomsonlinear.com/ll](http://www.thomsonlinear.com/ll)



### Electrak MD

Designed as a smaller sibling to the Electrak HD actuator, these smart electric linear actuators pack a big punch relative to their compact size and dutifully perform in the harshest environments without the need for service or maintenance. Onboard controls open the door to a wide range of possibilities, including CAN bus options and low-level switching with or without position feedback.

[www.thomsonlinear.com/md](http://www.thomsonlinear.com/md)



Specifications		
	Electrak LL	Electrak MD
Screw type	ball	acme
Manual override / anti-rotation / dynamic braking	yes / yes / yes	no / yes / optional
Static load holding / internal limit switches	yes / yes	yes / yes
Available input voltages [VDC]	24	12, 24
Max. static load / dynamic load (Fx) [N (lbs)]	18000 (4050) / 6000 (1349)	2000 (450) / 2000 (450)
Speed @ no load/max. load [mm/s (in/s)]	30 (1.18) <sup>(1)</sup>	52/43.8 (2.04/1.72)
Max. ordering stroke (S) length [mm]	500	300
Operating temperature limits [°C (F)]	- 40 - 85 (- 40 - 185)	-40 - 85 (-40 - 185)
Full load duty cycle @ 25 °C (77 °F) [%]	35	25
Protection class - static	IP66 / IP69K	IP67 / IP69K
Salt spray resistance [h]	500	500

<sup>1</sup> Constant speed motor.



## Smart Actuator Feature Breakdown

It's all about control. With onboard electronics allowing you to make standalone controls a thing of the past, a new world of interconnected possibilities awaits your machine designs.

The Thomson Electrak® Modular Control System (EMCS) is the foundation for the best onboard controls currently available in electric linear actuators, and includes standard and optional features such as built-in CANopen® or SAE J1939 CAN bus support. This level of control helps save design and installation time, as well as space and installation cost. Plus, a generous selection of control configurations can tailor your smart actuator to fit a wide breadth of heavy duty applications.

### Low-Level Switching



Onboard electronics limit current draw at switches or contacts to a maximum of 22 mA, enabling a simplified and less expensive system design. These low-current signals can be used to program actuators to extend, retract or stop the tube, providing a soft start. This improves safety by reducing the hazard of electrical shock, and puts less stress on system batteries and charging systems. An auto sleep feature also helps improve efficiency by reducing power consumption during idle or dwell periods.

### Brushless Constant Speed Motor



Brushless constant speed motors offer longer life, higher duty cycle and predictable cycle times as the speed is constant as long as the motor operates within its load limits.

### Analog Position Feedback



A high-quality potentiometer with essentially infinite resolution and low noise provides a voltage signal for position and direction feedback.

### Digital Position Feedback



An encoder provides either a single- or double-channel pulse train for position and speed feedback, which can be used to synchronize actuators via a control system.

### Speed Control



This feature allows the actuator speed to be controlled via an analog input signal or as CAN bus commands to optimize the speed of every extension tube move.

Electrak XD

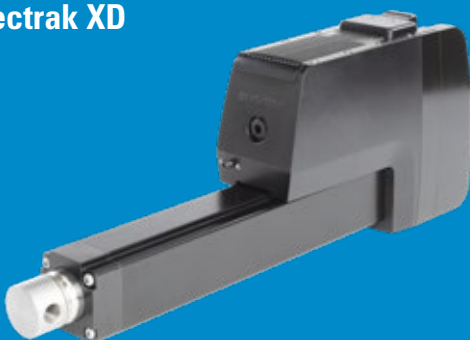

Electrak HD



### Force Feedback

The force feedback function transmits the force applied to the extension tube over an analog signal or as a CAN bus message. In force-sensitive applications, this feature will allow the system to not go over or under the desired force.

### Programmable End-of-Stroke Limits

This feature lets you program exactly how much of the full mechanical stroke of the actuator you want to use.

### Synchronization

This option allows two or more actuators to share a load. Designers are able to take advantage of a more stable and potentially quicker lift, no additional guides, and improved handling of uneven loads. With these controls integrated into the actuators, installation and system wiring are simplified.

### Monitoring and Diagnostics

Constant monitoring of critical parameters such as voltage, speed, force and temperature protects the actuator and machine by preventing motion if outside normal ranges. Current monitoring is a critical safety feature that shuts down the actuator on overload and eliminates the need for the traditional noisy mechanical clutch. Internal end-of-

stroke limit switches are built into select actuators to ensure smooth, repeatable operation and protect both connected equipment and the actuator.

### Simplified Control Architectures

When adding CAN bus, your control system and actuators can communicate directly with each other. The installation is fast and easy, requiring only a two-wire bus cable and power to extend the network, and any other equipment with CAN bus can be connected for additional communication. The result is a less complex system to design, better performance and controllability, and reduced installation time and overall cost.

### Remote Access and Communication Protocols

Integrated electronics make it possible for actuators to apply networking standards, such as CANopen or SAE J1939, high-level communications protocols that provide a standard messaging structure for communications among network nodes under control of an electronic control unit. While these protocols are popular for off-highway applications, actuators with integrated electronics are increasingly applied in plant floor, material handling and other applications.

Electrak LL



Electrak MD





## Reaching New Markets and Applications

Smart actuators are increasingly finding their way into applications that were once dominated by pneumatic and hydraulic systems. The mobile off-highway (MOH) vehicle market was among the first to deploy electric actuators for enhanced control and automation capabilities available in the field. However, other industries have begun to realize the many benefits of smart actuators.

### Autonomous Vehicles

- Advanced position and speed control, force feedback, bus communication, and synchronization of multiple actuators.
- High power density for more compact and efficient equipment.
- Safer and cleaner environment mainly due to elimination of problems related to hydraulic fluids.
- Robust and reliable operation, even in demanding environments, ensured by Thomson high testing standards.
- Easy installation and maintenance free.

### Agricultural, Construction and Marine Systems

- Simplified, less expensive system design due to easier integration with existing electrical control systems and networks.
- Increased motion control capabilities via position control and feedback, force feedback, and out-of-the-box options for bus communication.
- Cleaner environment as a result of no fluids, chemicals or solvents necessary for operation.
- Increased operator safety as potentially dangerous tasks can be controlled from inside the machine cabin or wheel house.

### Factory Automation and Material Handling

- Bus communication, low-level switching, intermittent duty cycles and high power density offered in a compact envelope.
- Safer, quieter, cleaner and more reliable operation.
- Simplified control with monitoring of operation-critical parameters.



### Domestic, Office and Hospital Equipment

- Manual-to-electromechanical conversion assists with load and ergonomics, while saving time for users/patients.
- Programmable positions, including sitting and standing at a workstation or desk.
- Safer and cleaner environment, highlighted by elimination of hydraulic fluid replacement and leaks.
- No need for wall outlets when operating the actuator with a battery as a power source.

- Saves energy due to lack of power consumption when holding a static load.
- Easy to integrate into home automation systems compared to other mechanical solutions.
- Enhanced safety with interlock functionality and several connected axes able to communicate with each other.





## Smart Autonomous Vehicles on the Move

When vehicles are designed to move autonomously and communicate with operators and other machines within an integrated system, smart actuators are given a golden opportunity to shine. Not only do these actuators provide users with a multitude of enhanced control options, they help ensure the safety of the vehicles and any nearby workers.

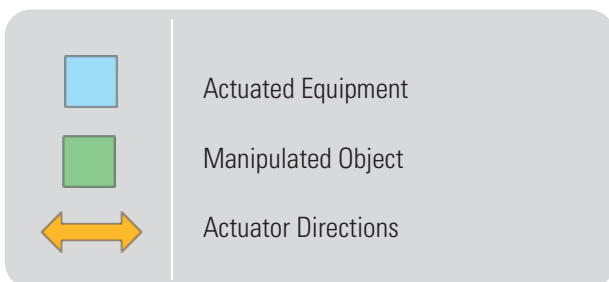
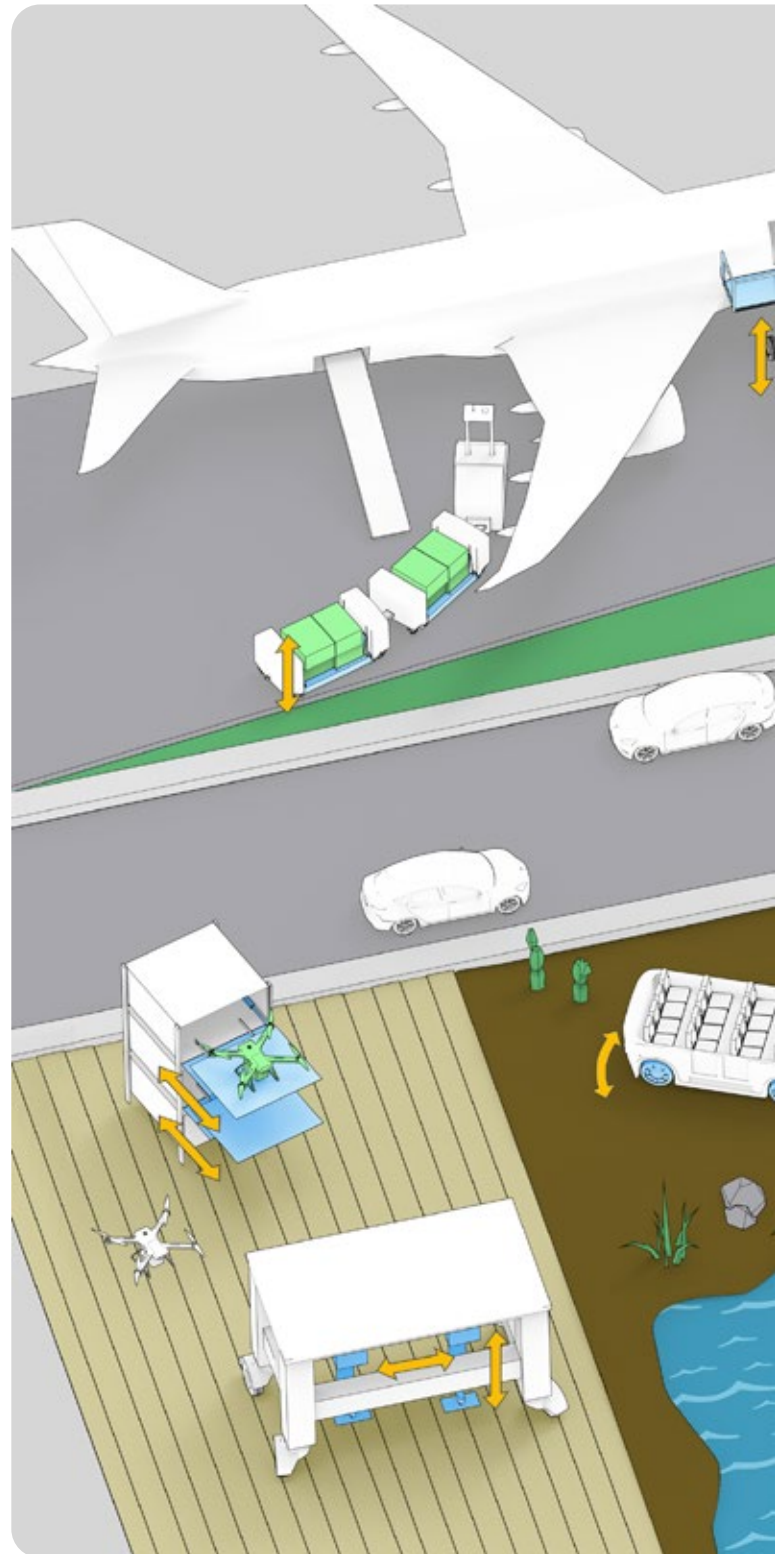



For further detail on autonomous vehicle applications that benefit from smart actuators, see the next page.



## Autonomous Vehicles at Work Everywhere on the Globe

### Indoor and Outdoor Material Handling

- Autonomous vehicles such as logistics trains and forklifts can benefit from the enhanced controllability of Thomson smart linear actuators. This capability, which includes bus communication, feedback and diagnostics, allows the actuators to work with a central computer and other smart components for improved logistics flow. It also directly impacts waste reduction, and time and energy savings.
- For AGVs without human involvement, remote control over radio, WiFi, satellite and other communications is vital. In addition to their remote benefits, smart actuators reduce maintenance and environmental concerns thanks to sturdy designs. This all-in-one actuator package makes it possible for AGVs to move goods over larger areas no matter how demanding the conditions.

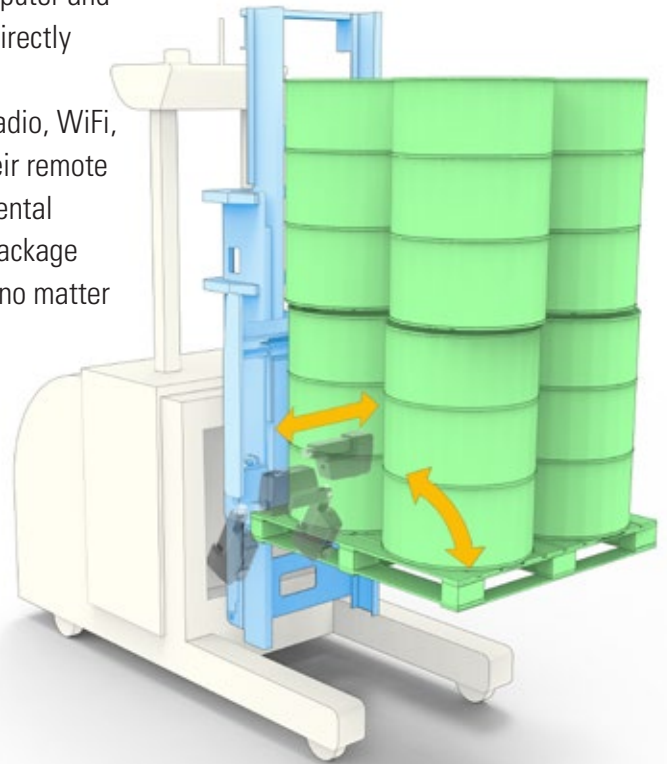
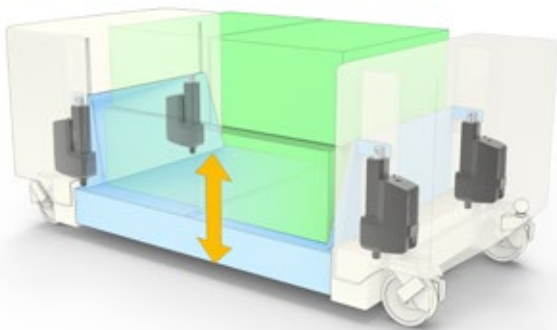

### Gardening, Cleaning and Utility Vehicles

- Electric actuators are designed to handle the repetitive movements on these automated utility vehicles with the added benefit of a robust design that can handle dirty and wet environments, as well as integrated controls to ensure proper autonomous movement.

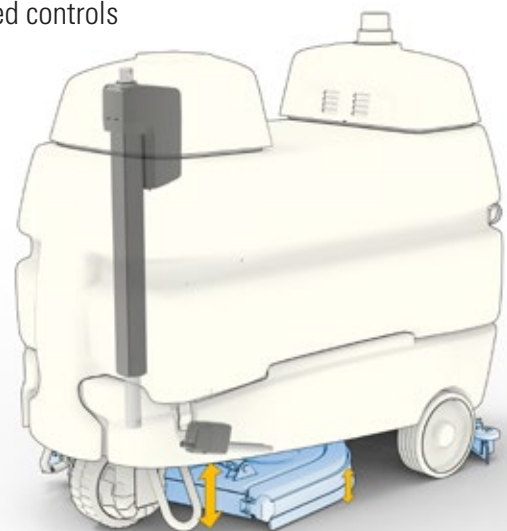
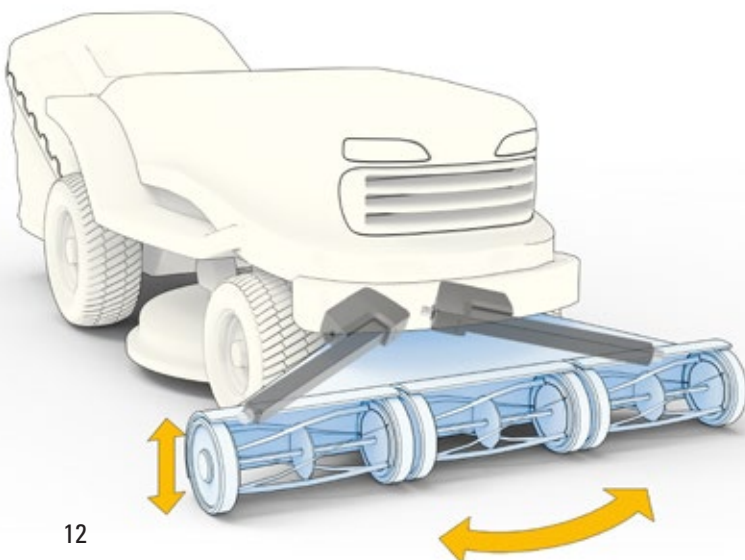

## Drones

- Electric actuators automate remote stations like this drone platform to allow deployment in otherwise hard-to-reach areas. All the while, onboard diagnostics ensure the machines are in good working order.
- Automating movement of mobile drones with no human involvement is a prime candidate for electric actuators as they are maintenance free.

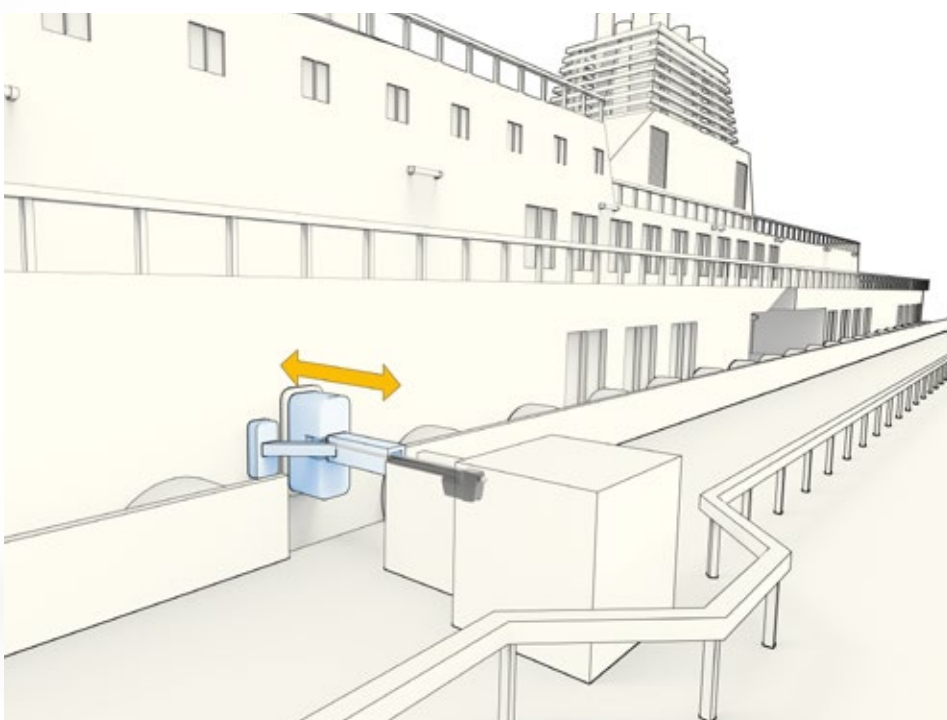
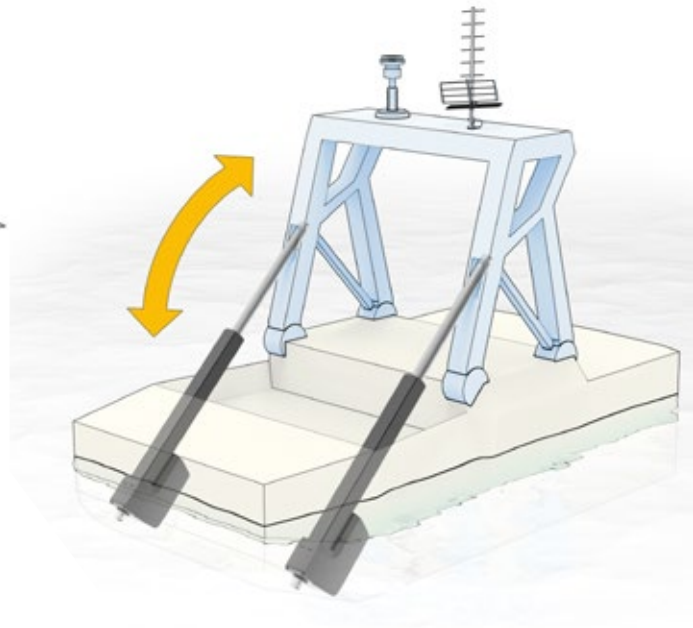
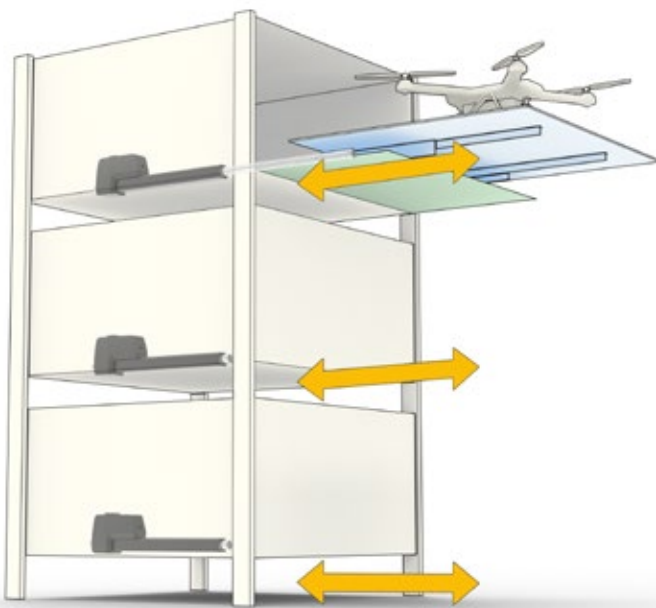

## Charging, Filling and Emptying

- Applications like this docking mechanism for large ferries are sometimes dangerous and cumbersome for human involvement. Automating these ferries raises the demand for an automated system even more, and Thomson smart electric actuators make the most sense as they are fully controllable, maintenance free, and can easily communicate with other mechanisms (like the ferry itself) via bus communication.



## Take Smart Actuators On and Off the Highway

On land, water or any other terrain, efficient linear motion control on vehicles, machines and equipment helps keep businesses moving. In these applications, you will find smart actuators making their biggest impact.

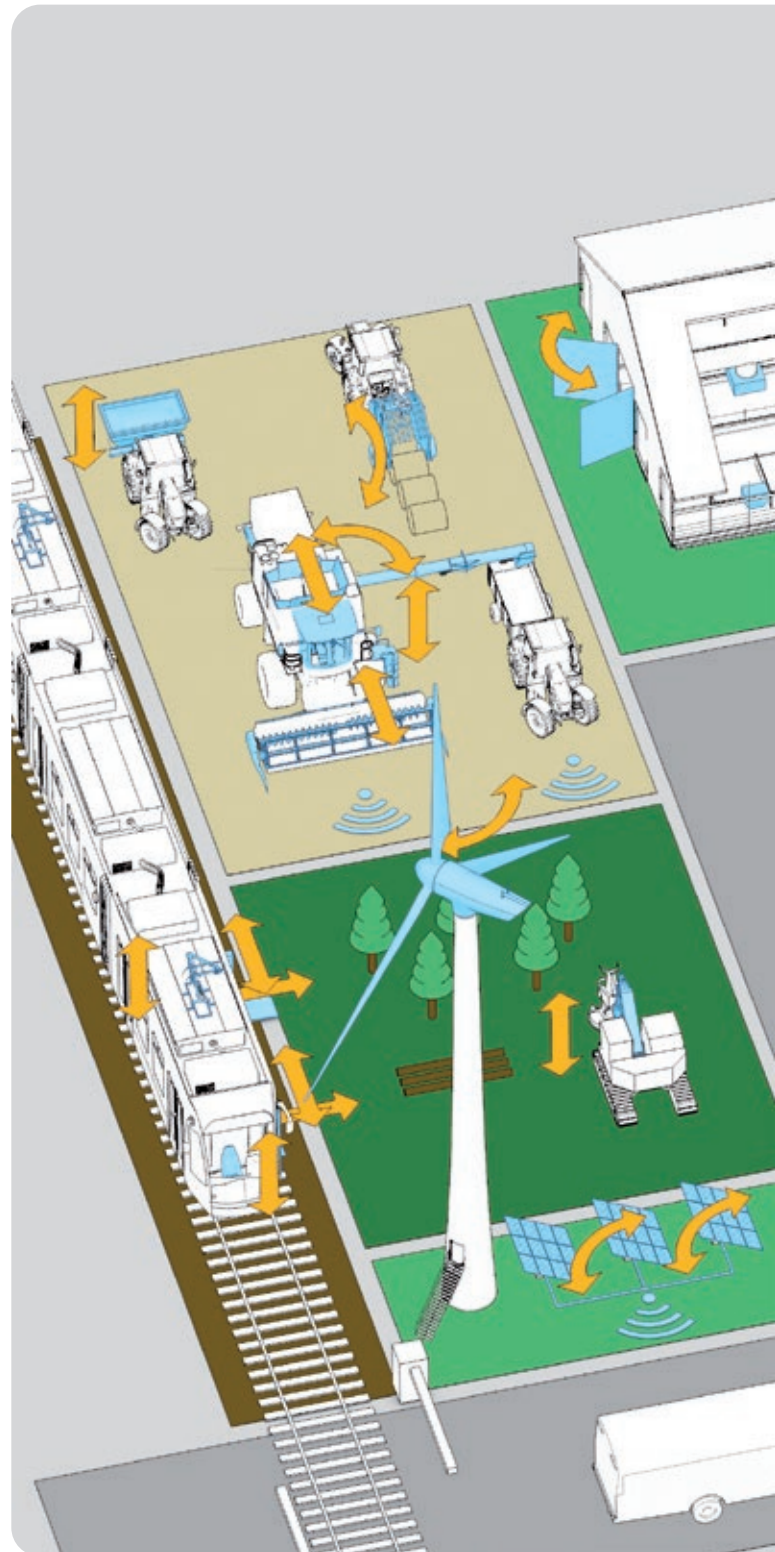
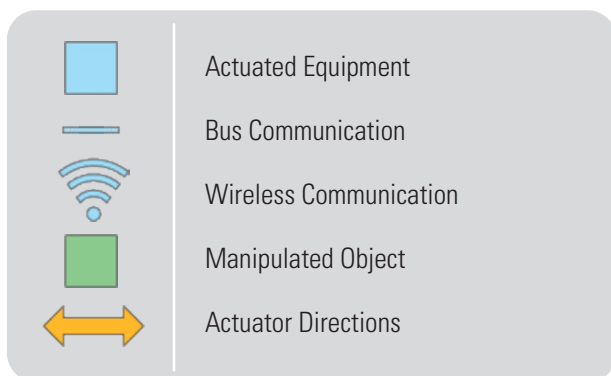

### Actuators on the Move

Whether it be for agricultural vehicles, marine vessels or public transportation, smart actuators are an excellent choice for a wide array of tasks. These help increase productivity and quality, improve safety and ergonomics, and reduce fuel and maintenance costs.

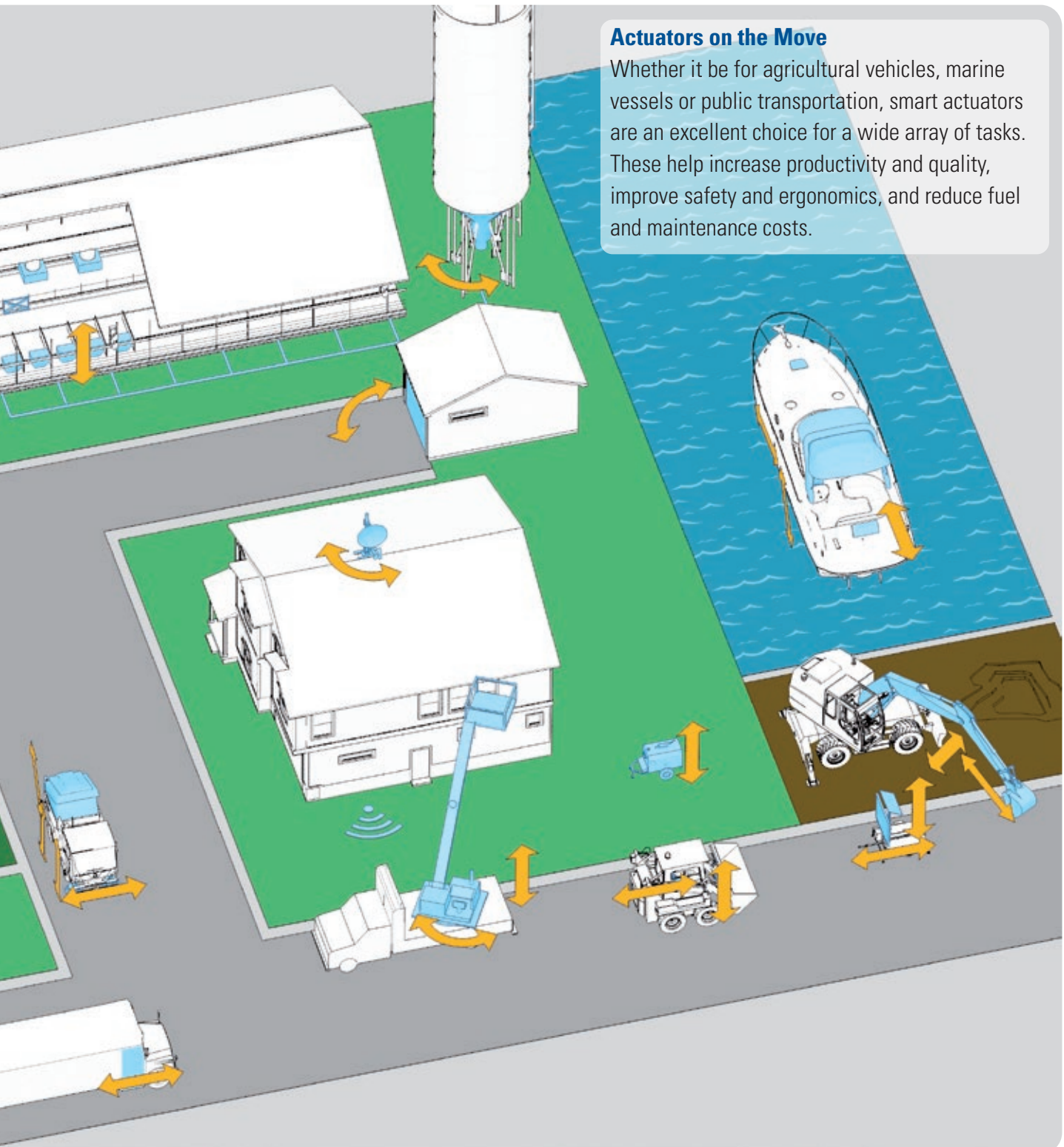

For further detail on on/off-highway applications that benefit from smart actuators, see the next page.



## Make Your Environment Smarter

### Combines

- Electric actuators are ideal for hard-to-reach places that may require complex control to function.
- Integrated electronics allow you to drop in an actuator where a more complicated control scheme for hydraulics or air would have been previously.
- Common applications include sieve leveling, auger tube fold, hood lift and grain bin cover.

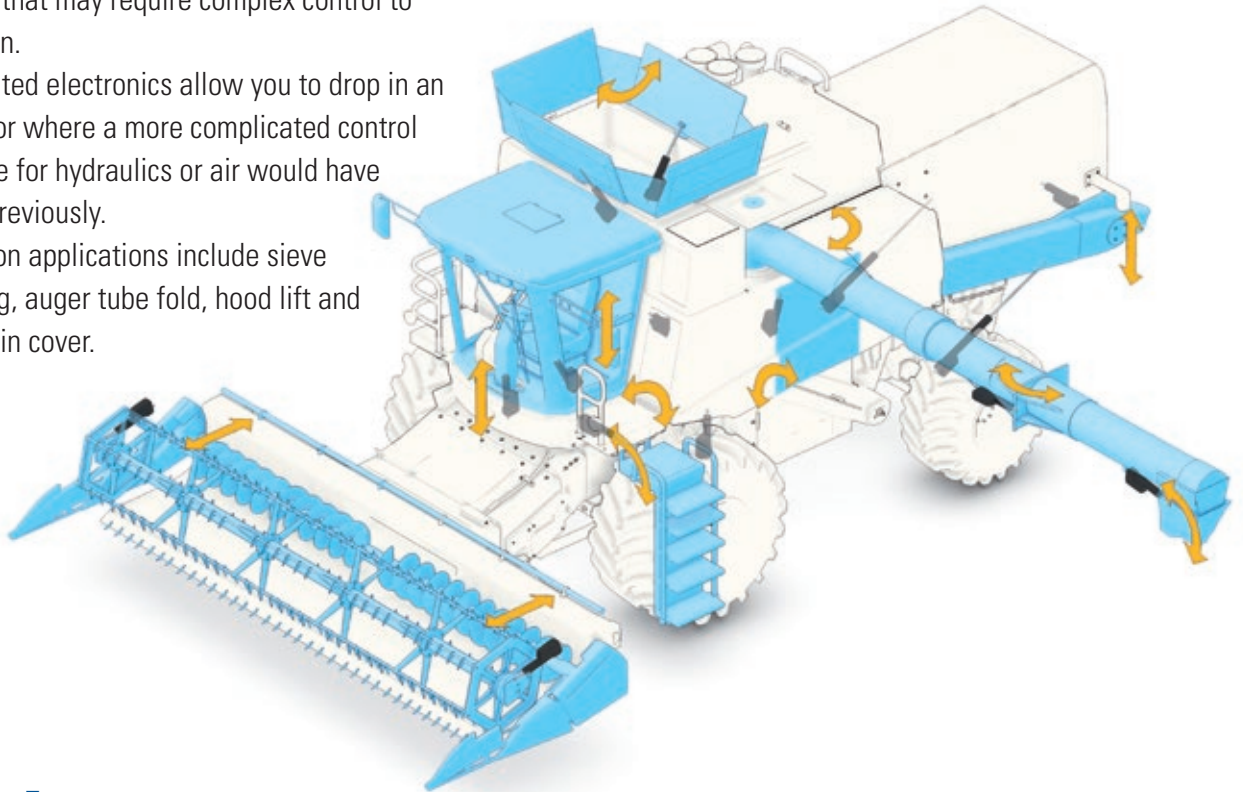

### Skid Steer Excavators

- These utilize a quick-attach system to connect and disconnect multiple attachments to the front of the vehicle.
- Reliable Thomson smart actuators integrate into the cab controls to provide the convenience of swapping attachments without having the operator exit the cab.
- Position feedback allows the operator to confirm the implement (i.e. bucket) is securely locked before deploying the machine.

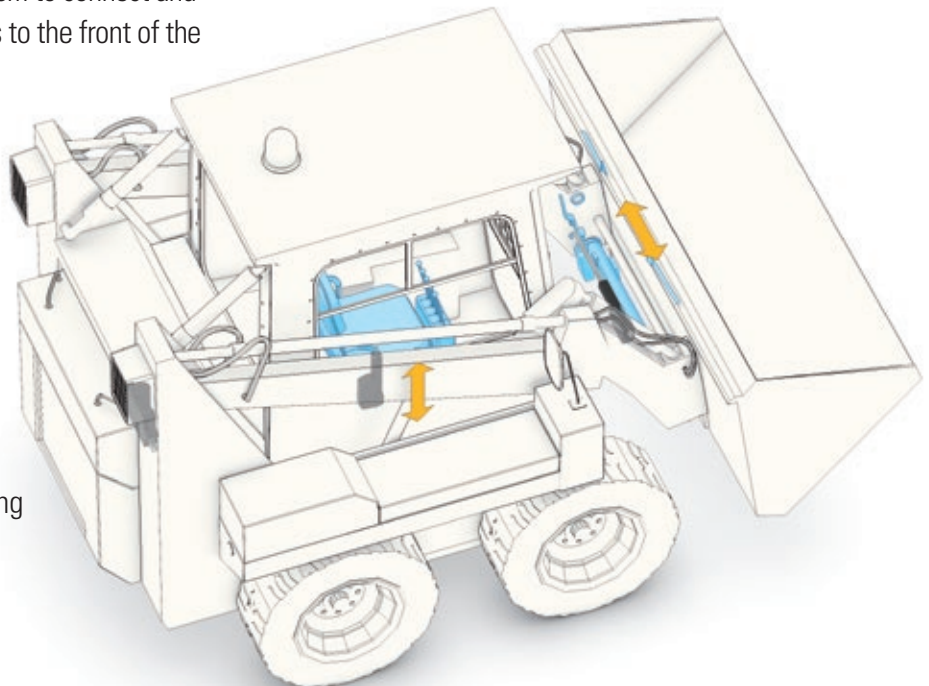

## Marine Vessels

- Thomson smart actuators' rating for IP67 (static), IP69K (static) and IP66 (static/dynamic) address the strict sealing capabilities required by electronics integration.
- Corrosion-resistant coatings and surface treatments prevent oxidation in high-salinity environments.
- Applications include seat adjustments, engine hatch and wakeboard tower automation, and throttle and shift actuation.

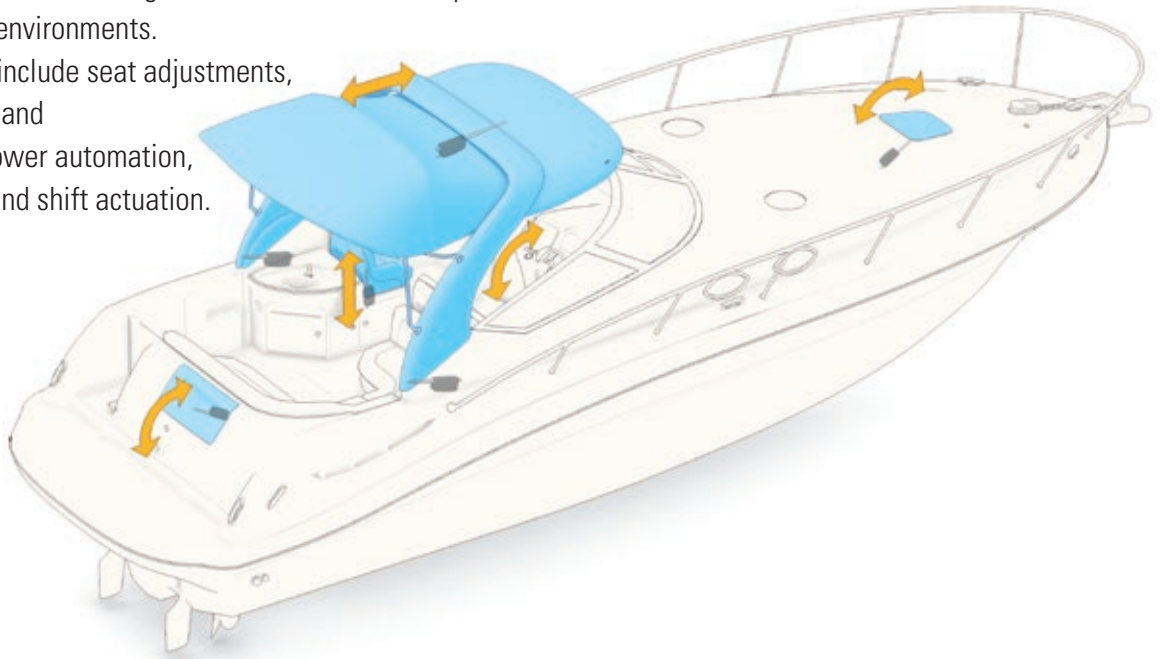

## Public Transportation

- Smart actuators are more environmentally friendly and cost effective than hydraulic and pneumatic systems.
- Trains and buses using actuators for pantographs benefit from their robust construction to achieve long life in harsh environments.
- Overload sense and confirmed position are vital to user safety.
- Other public transit applications include door actuation, step leveling and gap control.

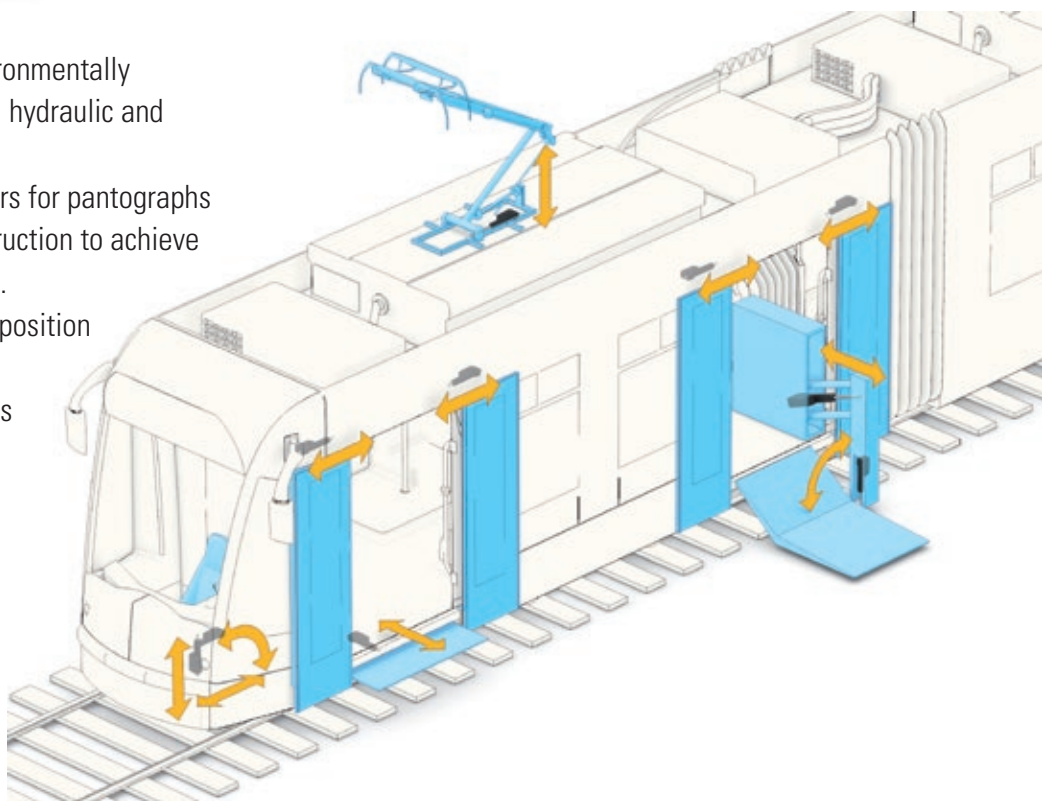



## Building a Smarter Factory

An interconnected factory is a productive, efficient factory. Once smart actuators are introduced into a facility's automation process, the benefits are immediate and exponential.

Machine design is simplified with increased flexibility and plug-and-play functionality, control capabilities are enhanced, energy usage is decreased, maintenance and downtime experience significant reductions, safety and ergonomics improve, and overall costs are lessened.

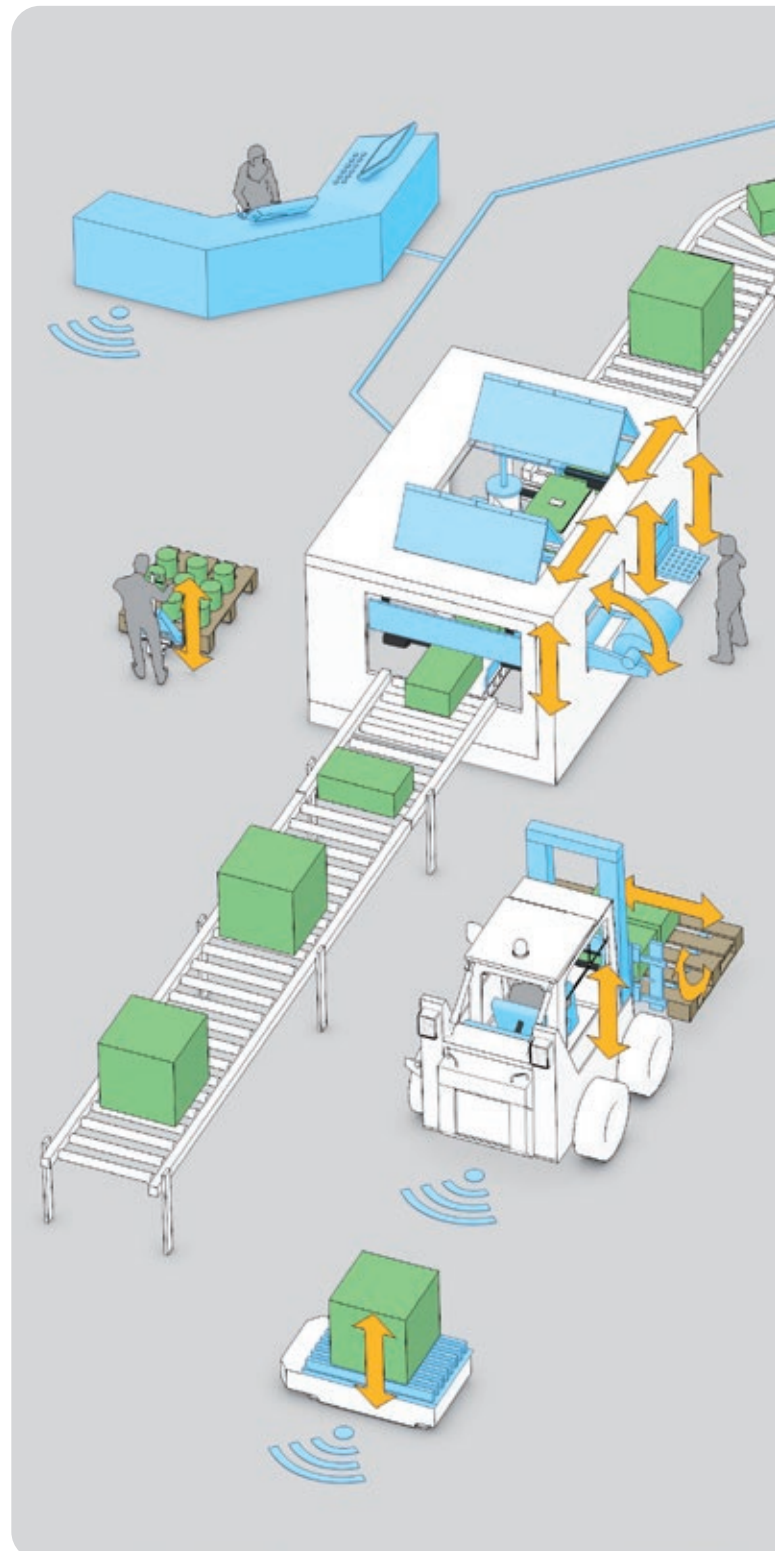
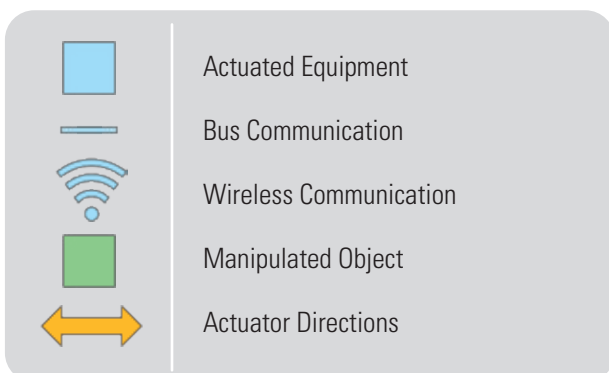

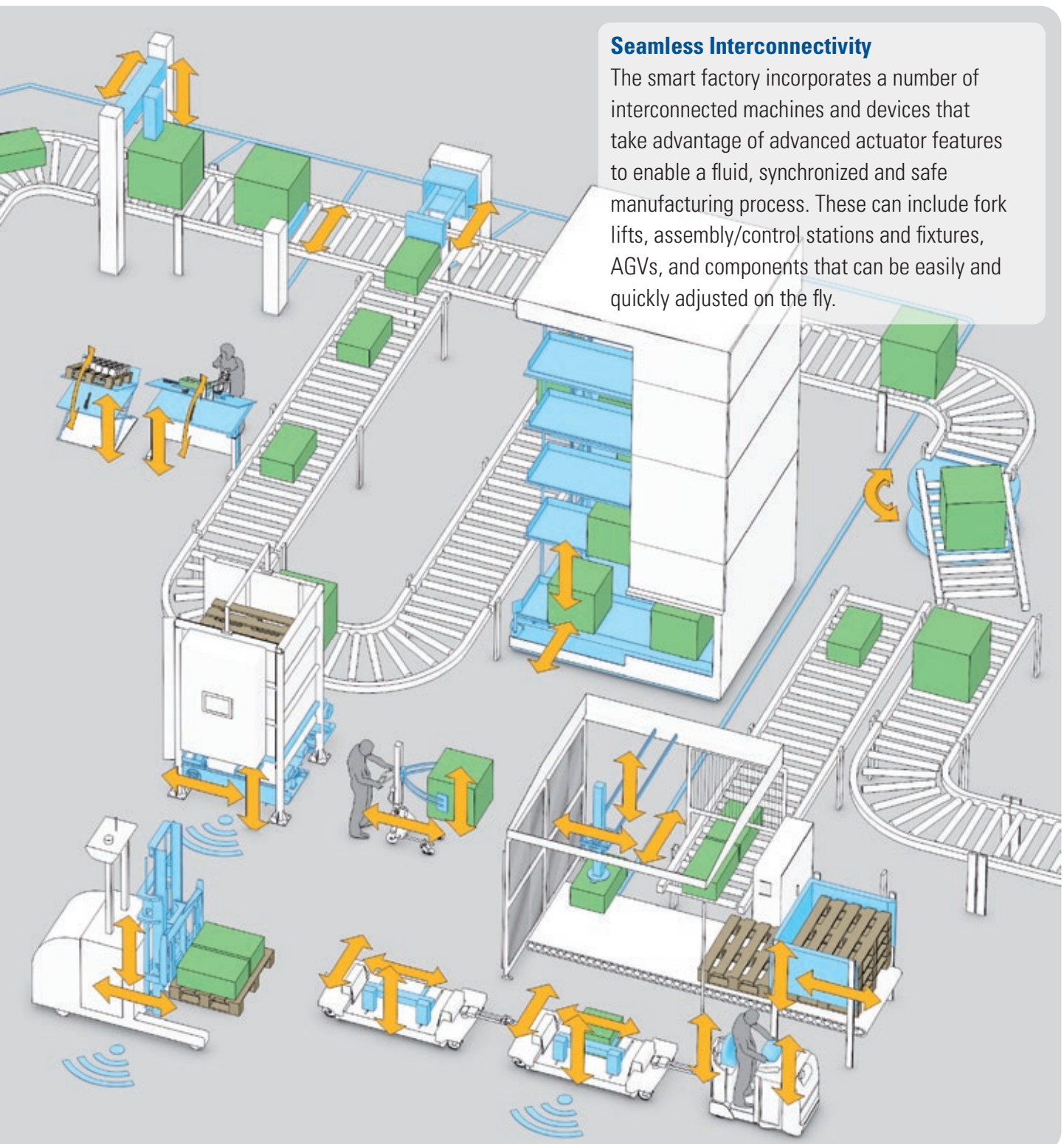

For further detail on factory applications that benefit from smart actuators, see the next page.



## A Closer Look at Smart Actuators in the Factory

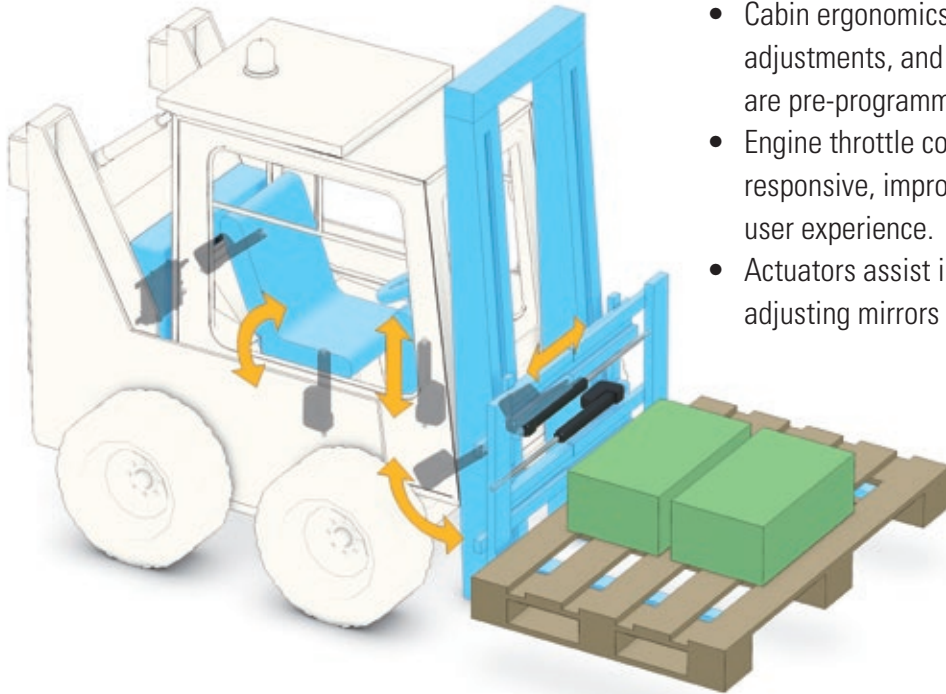

### Fork Lifts

- Cabin ergonomics are improved with seat adjustments, and individual, user-defined settings are pre-programmed for quick changes.
- Engine throttle control is more precise and responsive, improving fuel consumption and the user experience.
- Actuators assist in opening hoods and doors, and adjusting mirrors and ladders.

### Machine Operation and Safety

- Easy-to-build interlock functions prevent machines from functioning when hatches are open.
- In flexible manufacturing, machines often need to be adjusted when changing the size or type of product being produced. In these instances, bus-controlled actuators are programmed to adjust machine settings (e.g. fences or diverters) according to the processing parameters of that particular product.

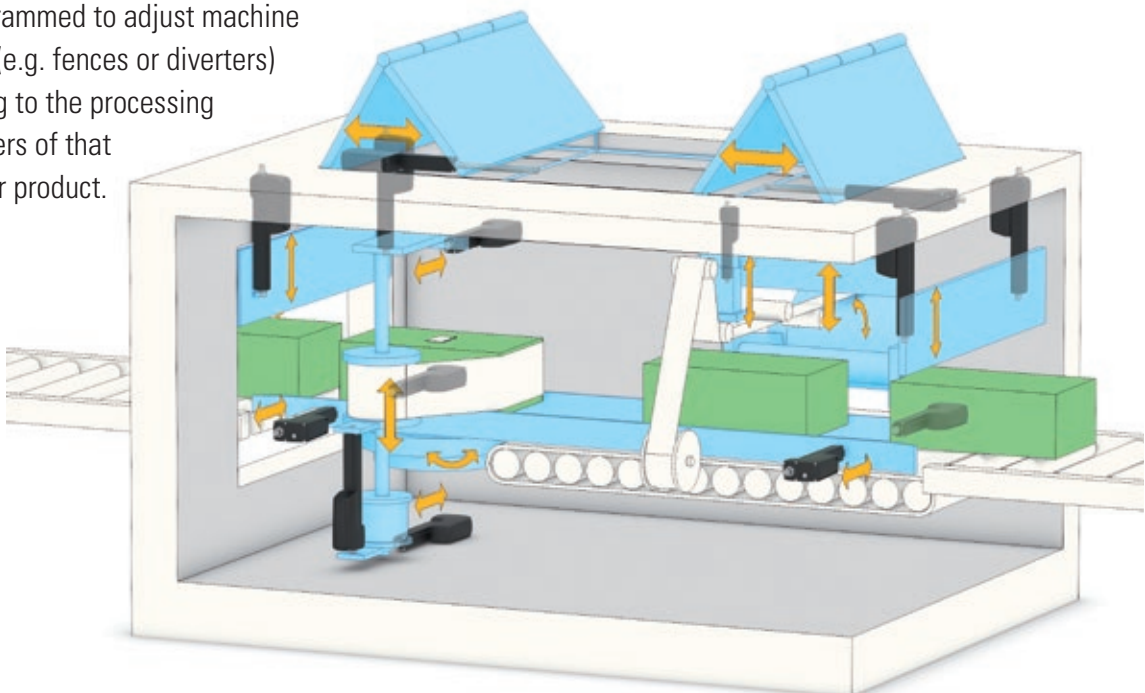

### Assembly/Control Stations and Fixtures

- Operators adjust their workplaces to minimize the risk of injury, while securing material and other equipment during the assembly process.
- The burden of heavy and/or repetitive lifts is eliminated.

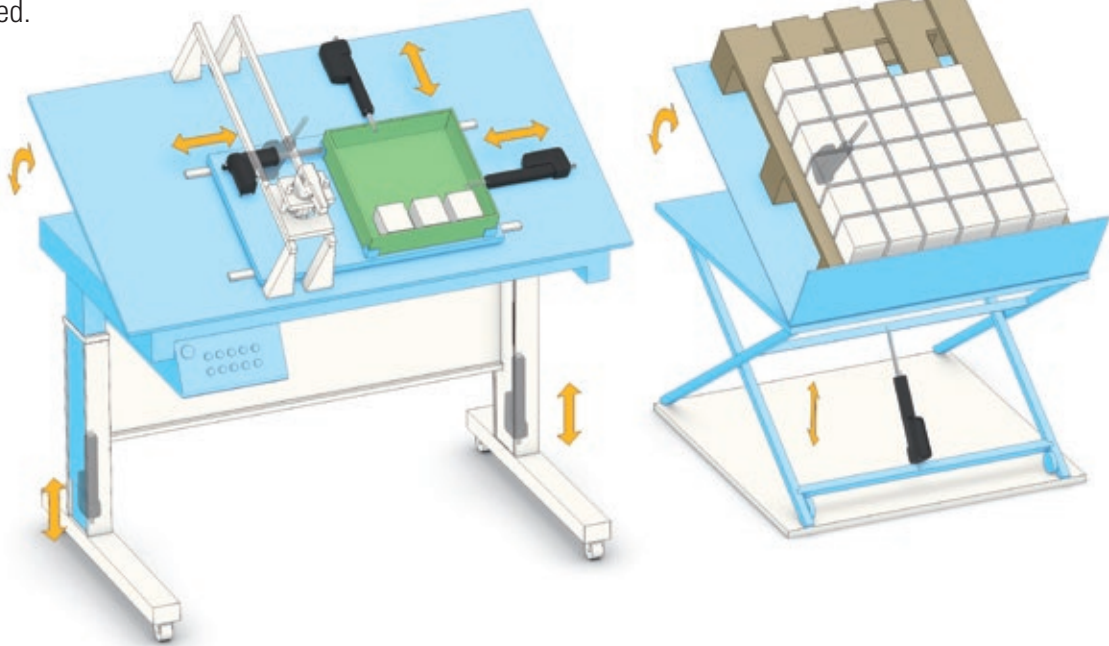

- Compared to pneumatic or hydraulic solutions, electric actuators achieve improved controllability, greater accuracy, less noise, cleaner operation and reduced operating costs.

### Logistic Trains and AGVs

- Precise control, reliable feedback and no creeping at a standstill allow you to control forks, tools and other functions in order to pick, place and handle material or goods.
- With all functions electrically powered, the complexity of the total system is reduced.
- High loads are held with no power, optimizing the battery life and reducing the charging intervals.

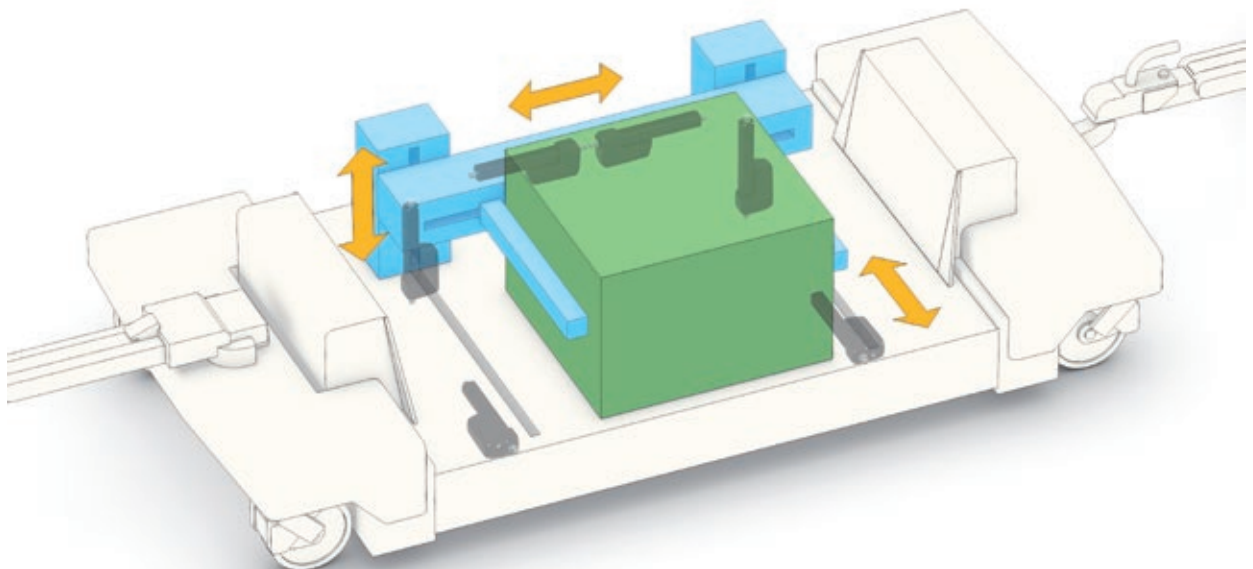



### Improving Your Quality of Life

On any given day, you are more than likely benefitting from a structural automation application using smart actuators. At home on the patio, in your office, at the gym during your lunch break or in your doctor's office, your life is being made easier, more comfortable or just a little better thanks to a smart actuator.

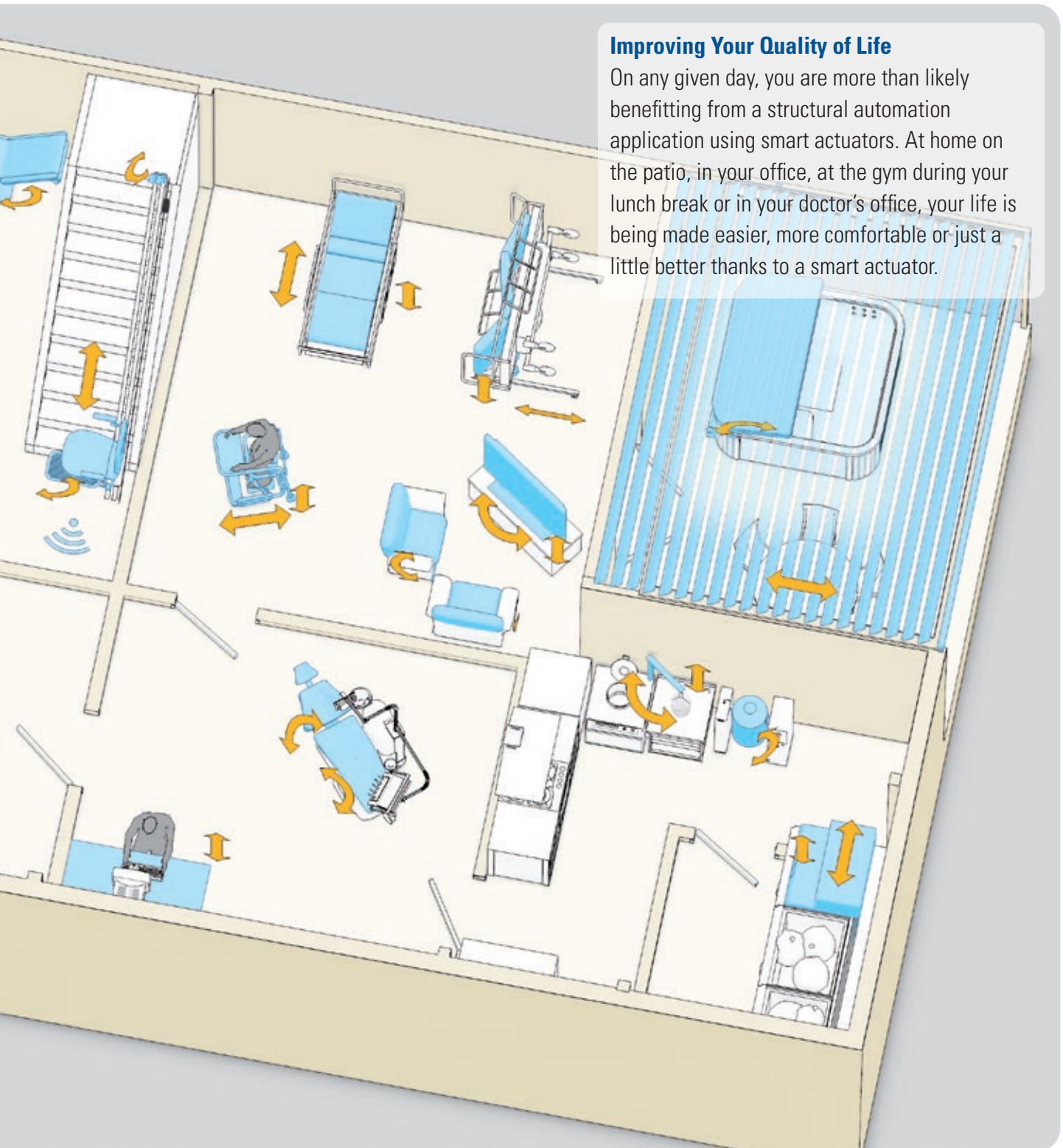

For further detail on structural automation applications that benefit from smart actuation, see the next page.



## A Closer Look at Structural Automation

### Patio Roofs

- Automated roof systems offer the convenience of a push-button solution to open and close the louvers on an outdoor pergola.
- The power-dense Electrak® MD actuator provides control with a variety of electronic feedback options.
- Provides hassle-free actuation to an otherwise manual operation.

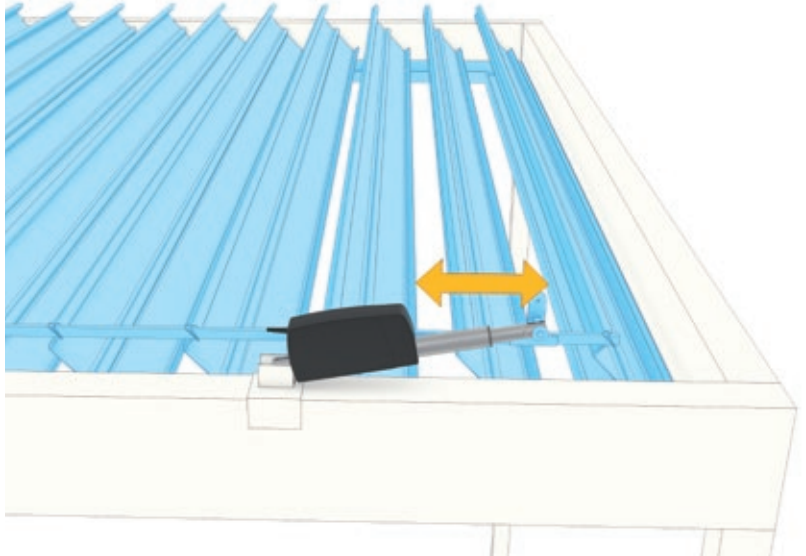

### Kitchen Equipment

- Thomson smart actuators deliver enhanced controllability to industrial kitchen applications.
- OEMs benefit from an electromechanical solution that is cleaner and more efficient than many pneumatic and hydraulic alternatives.
- The actuators fit into the application without a complicated control package.

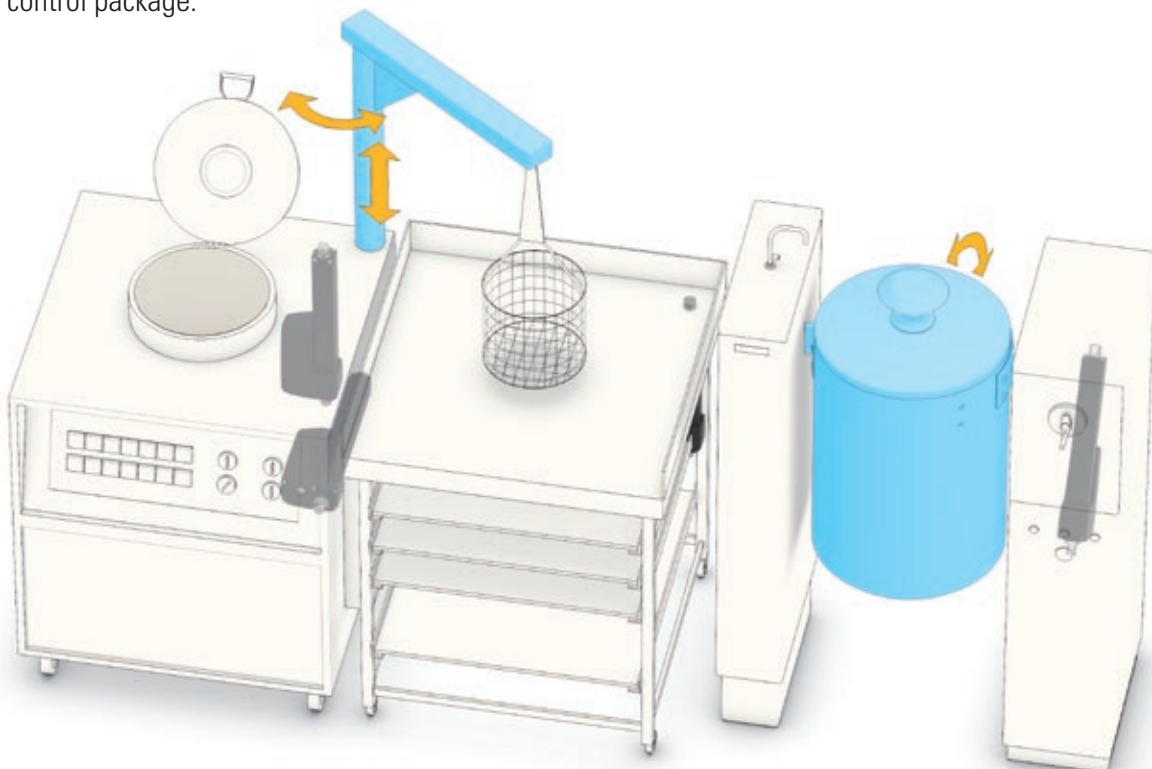

### Garbage Compactors and Recycle Stations

- Employed primarily in commercial kitchens, bakeries, shops, restaurants and warehouses.
- Operate more quietly and easily with the use of electric actuators.

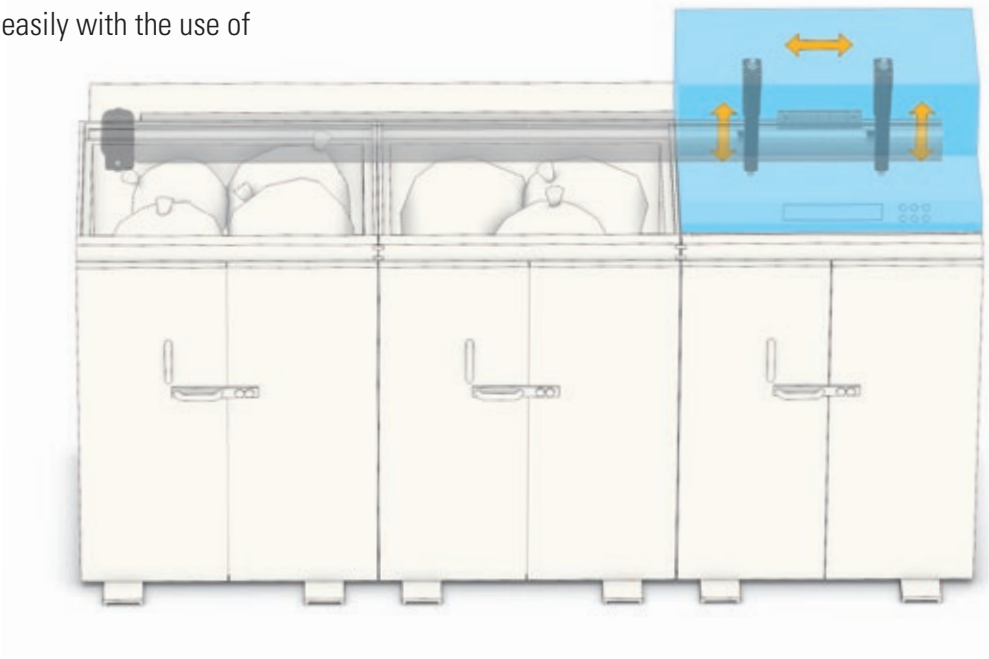

### Staircase Lifts

- Used typically in homes or offices where electricity is the only available power source.
- Smart actuators are ideal for many lift functions depending on the style and configuration.
- Examples include seat leveling, tilting of the seat and foot rest, and extending and retracting the rail at the end of the staircase.





## Smart Online Resources

Thomson offers a wide variety of online tools to help you in the selection process. An experienced team of application engineers is also available to help size and select a smart actuator model to best fit your needs. To explore additional technical resources and options, contact Thomson customer support at [www.thomsonlinear.com/contact](http://www.thomsonlinear.com/contact).

### Sizing and Selection Tool

Complete a self-guided, interactive series of questions to quickly and accurately find your ideal actuator solution.

[thomsonlinear.com/en/products/linear-actuators](http://thomsonlinear.com/en/products/linear-actuators)



### Technical Videos

Learn more about Thomson linear actuators, including their features, benefits and applications, as well as technical definitions and how-to's.

[thomsonlinear.com/en/support/technical-videos](http://thomsonlinear.com/en/support/technical-videos)



### Actuator Selector Tool

Using a simplified, application parameter-based selection process, quickly narrow your actuator search, access 3D models, upfront pricing and lead times, and purchase instantly.

[thomsonlinear.com/en/products/linear-actuators](http://thomsonlinear.com/en/products/linear-actuators)



### Interactive 3D CAD Models

Download free interactive 3D models in the most common CAD formats to assist in your design projects.

[thomsonlinear.com/en/products/linear-actuators](http://thomsonlinear.com/en/products/linear-actuators)

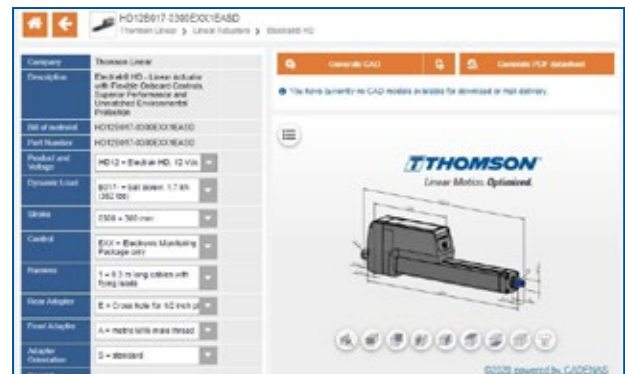

## Getting Smarter Every Day

The building blocks of Thomson's current line of smart electric linear actuators began in 1967 with the introduction of our first model. Over the years, our engineers have worked closely with customers to learn what intelligent features and technologies can help them best achieve their application requirements. See below for a timeline of our groundbreaking smart actuator developments.

**2006**

**Electrak Pro**, the first Thomson linear actuator with a modular onboard control concept in a one-size housing, is released.



**2013**

**Electrak Throttle**, Thomson's first CAN bus control actuator, is released.

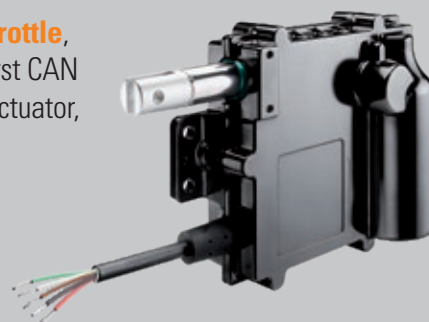

**2016**

**Electrak HD**, the first truly smart actuator and a milestone in actuator engineering, is released, redefining what linear actuators are and can be used for.



**2020**

**Electrak MD** is released, broadening the smart actuator range into the compact segment.



**2021**

**Electrak LL**, a smart and sturdy long-life actuator with synchronous motor and superior environmental protection, is released.



**2023**

**Electrak XD**, the first electric actuator to be strong enough to truly contend with hydraulic cylinders, is released, and is equipped with all of the standard advantages associated with Thomson smart actuators.



Contact us or any of our 2000+ global distribution partners by scanning the code below  
or visiting [www.thomsonlinear.com/contact](http://www.thomsonlinear.com/contact)



**RegalRexnord™**

[www.regalrexnord.com](http://www.regalrexnord.com)

[www.thomsonlinear.com](http://www.thomsonlinear.com)

Smart\_Actuation\_BRUK-0027-05 | 20260126TJ | MCB-12403-TL-EN-A4 02/26  
Specifications are subject to change without notice. It is the responsibility of the product user to determine the suitability of this product for a specific application. All trademarks property of their respective owners.  
©2026 Thomson Industries, Inc. | 2400 Curtiss Street, Downers Grove, IL 60515 USA

**THOMSON®**